

DH-SD49425XB-HNR

4MP 25x Starlight IR WizSense Network PTZ Camera



Wiz Sense

- 1/2.8" 4Megapixel CMOS
- Powerful 25x optical zoom
- Starlight technology
- Max.25/30fps@4M
- Perimeter protection
- Support PoE+
- IR distance up to 100m
- SMD PLUS
- IP66



Launched by Dahua Technology, WizSense is a series of AI products and solutions that adopt independent AI chip and deep learning algorithm. It focuses on human and vehicle with high accuracy, enabling users to fast act on defined targets. Based on Dahua's advanced technologies, WizSense provides intelligent, simple and inclusive products and solutions.

System Overview

Dahua PTZ WizSense network camera adopts advanced CNN deep learning algorithms to support Perimeter Protection with high accuracy. This camera possess wide monitor range, PFA algorithm that can always present a clear, focused image while zooming. The camera has very excellent low light performance due to adopting the latest starlight technology. The camera is equipped with smooth control, high quality image and good protection, which make it can meet most of the requirements of video surveillance applications.

Functions

Starlight Technology

For challenging low-light applications, Dahua's Starlight Ultra-low Light Technology offers best-in-class light sensitivity, capturing color details in low light down to 0.005 lux. The camera uses a set of optical features to balance light throughout the scene, resulting in clear images in dark environments.

Wide Dynamic Range

The camera achieves vivid images, even in the most intense contrast lighting conditions, using industry-leading wide dynamic range (WDR) technology. For applications with both bright and low lighting conditions that change quickly, True WDR (120 dB) optimizes both the bright and dark areas of a scene at the same time to provide usable video.

Perimeter Protection

Automatically filtering out false alarms caused by animals, rustling leaves, bright lights, etc. Enables system to act secondary recognition for the targets. Improving alarm accuracy.

Environmental

Dahua cameras operate in extreme temperature environments, rated for use in temperatures from -40 °C to +70 °C (-40 °F to +158 °F) with 95% humidity. Subjected to rigorous dust and water immersion tests and certified to the IP66 Ingress Protection rating makes it suitable for demanding outdoor applications.

Protection

The camera allows for 6KV lightning rating, which provides effective protection for both the camera and its structure against lightning.

Interoperability

The camera conforms to the ONVIF (Open Network Video Interface Forum) specifications, ensuring interoperability between network video products regardless of manufacturer.

PFA Technology

PFA technology has innovatively introduced new methods of judgment to ensure the accuracy and predictability of the direction of subject distance adjustment. The result is a set of advanced focusing algorithms. PFA ensures clarity of the image throughout the process of zooming and shortens focus time. The realization of PFA technology substantially improves user experience and increases product value.

SMD PLUS

With Deep-Learning Algorithm, Dahua SMD PLUS filters the motion detection alarm triggered by non-concerned target and recognizes human and vehicle effectively, sending alarms when human and vehicle intrude.

Technical Specification
Camera

Image Sensor	1/2.8" STARVIS™ CMOS
Pixel	4MP
Max. Resolution	2560 (H) × 1440 (V)
ROM	4GB
RAM	1GB
Electronic Shutter Speed	1/1 s–1/30,000 s
Scanning System	Progressive
Min. Illumination	Color: 0.005Lux@F1.6 B/W: 0.0005Lux@F1.6 0Lux@F1.6 (IR light on)
Illumination Distance	100 m (328.08 ft)
Illuminator On/Off Control	Zoom Prio/Manual/SmartIR
Illuminator Number	4

Lens

Focal Length	4.8 mm–120 mm			
Max. Aperture	F1.6–F4.0			
Field of View	H: 60.0°–2.5°; V: 30.8°–2.2°; D: 66.7°–2.9°			
Optical Zoom	25x			
Focus Control	Auto/Semi-Auto/Manual			
Close Focus Distance	0.1 m–1.5 m (0.33 ft–4.92 ft)			
Iris Control	Auto/Manual			
DORI Distance	Detect	Observe	Recognize	Identify
	2540 m (8333.33 ft)	1016 m (3333.33 ft)	508 m (1666.67 ft)	254 m (833.33 ft)

PTZ

Pan/Tilt Range	Pan: 0°–360° (endless) Tilt: -15°–90° (auto flip 180°)
Manual Control Speed	Pan: 0.1°–200°/s Tilt: 0.1°–120°/s
Preset Speed	Pan: 240°/s Tilt: 200°/s
Presets	300
Tour	8 (up to 32 presets per tour)
Pattern	5
Scan	5
Speed Adjustment	Support
Power-off Memory	Support
Idle Motion	Preset/Tour/Pattern/Scanning
Protocol	DH-SD Pelco-P/D (auto recognition)

General Intelligence

Event Trigger	Motion detection, Video tampering, Scene changing, Network disconnection, IP address conflict, Illegal Access, Storage anomaly
IVS	Object Abandoned/Missing

Artificial Intelligence

Perimeter Protection	Tripwire and intrusion. Support alarm triggering by target types (human and vehicle). Support filtering false alarms caused by animals, rustling leaves, bright lights, etc.
SMD PLUS	Support
Face Detection	Support
Smart Capture	Support human, motor vehicle and non-motor vehicle image capture.

Video

Compression	H.265+/H.265/H.264+/H.264/MJPEG (sub stream)
Streaming Capability	3 streams
Resolution	4M (2560 × 1440); 3M (2048 × 1536); 1080P (1920 × 1080); 1.3M (1280 × 960); 720P (1280 × 720); D1 (704 × 576/704 × 480); CIF (352 × 288/352 × 240)
Frame Rate	Main stream: 4MP/3MP/1080P/1.3MP/720P (1–25fps) Sub stream 1: D1/CIF (1–25fps) Sub stream 2: 1080P/1.3M/720P (1–25fps)
Bit Rate Control	Variable/Constant
Bit Rate	H.265/H.264: 3 kbps–20480 kbps
Day/Night	Auto(ICR)/Color/B/W
BLC	Support
WDR	120 dB
HLC	Support
White Balance	Auto/Indoor/Outdoor/Track/Manual/Sodium lamp/ Natural light/Street lamp
Gain Control	Auto/Manual
Noise Reduction	Ultra DNR (2D/3D)
Motion Detection	Support
Region of Interest	Support
Electronic Image Stabilization	Support
Electronic Defog	Support
Digital Zoom	16x
Flip	180°
Privacy Masking	Up to 24 areas, and up to 8 areas in the same view

Audio

Compression	G.711a; G.711Mu; AAC; G.722.1; G.726; MPEG2-Layer2; G.729
-------------	---

Network

Ethernet	RJ-45 (10/100Base-T)
----------	----------------------

Protocol	IPv4; IPv6; HTTP; HTTPS; SSL; TCP/IP; UDP; UPnP; ICMP; IGMP; SNMPv1/v2c/v3(MIB-2); ARP; RTCP; RTSP; RTP; SMTP; NTP; DHCP; DNS; PPPOE; DDNS; FTP; IP Filter; QoS; Bonjour; 802.1x
Interoperability	ONVIF Profile S&G&T; CGI
Streaming Method	Unicast/Multicast
User/Host	20
Storage	NAS; Local PC; Micro SD card (256G)
Browser	IE7 and newer versions Chrome 45 and earlier versions Firefox 52 and earlier versions Safari (no version restrictions)
Management Software	Smart PSS; DSS; DMSS
Mobile Phone	IOS/Android

Certification

Certifications	CE: EN55032/EN55024/EN50130-4 FCC: Part15 subpartB, ANSI C63.4-2014 UL: UL62368-1+CAN/CSA C22.2, No. 62368-1
----------------	--

Port

Audio Input	1
Audio Output	1
Alarm I/O	2/1

Power

Power Supply	DC 12V/3A PoE+ (802.3at)
Power Consumption	13W 21W (IR on)

Environment

Operating Temperature	-40°C to +70°C (-40°F to +158°F)
Operating Humidity	≤95%
Protection	IP66; TVS 6000V lightning proof; Surge protection

Structure

Dimensions	Φ160 mm × 295 mm (6.30" × 11.61")
Net Weight	3 kg (6.61 lb)
Gross Weight	4.8kg (10.58lb)

Accessories	PFB305W	Wall Mount Bracket
	PFA111	Mount Adapter
	DC12V/3A	Power Adapter
	PFA140	Power Box
	PFB300C	Ceiling Mount Bracket
	PFA120	Water-proof Junction Box
	PFA150	Pole Mount Bracket
	PFA151	Corner Mount Bracket
	PFB303S	Parapet Mount Bracket

Accessories

Included:



PFB305W
Wall Mount Bracket

Optional:



PFA111
Mount Adapter



DC12V/3A
Power Adapter



PFA140
Power Box



PFB300C
Ceiling Mount Bracket



PFA120
Water-proof Junction Box



PFA150
Pole Mount Bracket



PFA151
Corner Mount Bracket



PFB303S
Parapet Mount Bracket

Ordering Information

Type	Model	Description
4MP WizSense PTZ Camera	DH-SD49425XB-HNR	4MP 25x Starlight IR WizSense Network PTZ Camera, WDR, PAL
	DH-SD49425XBN-HNR	4MP 25x Starlight IR WizSense Network PTZ Camera, WDR, NTSC
	SD49425XB-HNR	4MP 25x Starlight IR WizSense Network PTZ Camera, WDR, PAL
	SD49425XBN-HNR	4MP 25x Starlight IR WizSense Network PTZ Camera, WDR, NTSC

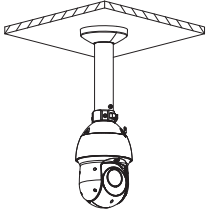
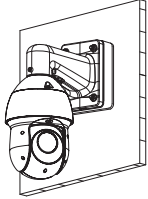
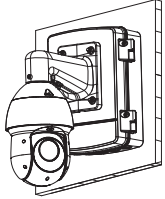
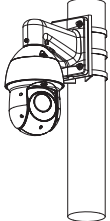
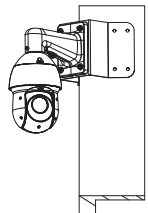
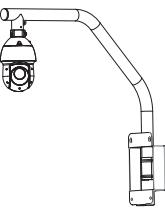
Ceiling Mount	Junction Mount	Power Box Mount
PFA111+PFB300C	PFB305W + PFA120	PFB305W + PFA140
		
Pole Mount	Corner Mount	Parapet Mount
PFB305W+PFA150	PFB305W+PFA151	PFA111+PFB303S
		

Dimensions (mm [inch])

