

## DH-SD6AL230F-HNI

---

### 2 Megapixel Full HD 30x Star Light Network Laser PTZ Dome Camera



#### Features

- Powerful 30x optical zoom
- Ultra-low light star light camera
- H.264 & MJPEG Three-stream encoding
- Max 60fps@720P and 30fps@1080P resolution
- Defog, WDR, EIS, ROI, Day/Night(ICR), DNR (2D&3D), Auto iris, Auto focus, AWB, AGC,BLC
- Auto-tracking and IVS
- Multiple network monitoring: Web viewer, CMS(DSS/PSS) & DMSS
- Max 240°/s pan speed, 360° endless pan rotation
- Up to 300 presets, 5 auto scan, 8 tour, 5 pattern
- Built-in 7/2 alarm in/out
- Support intelligent 3D positioning with DH-SD protocol
- Micro SD memory, IP67, Hi-POE
- Laser beam distance up to 500m

## DH-SD6AL230F-HNI

### Technical Specifications

<b>Model</b>	<b>DH-SD6AL230F-HNI</b>
<b>Camera</b>	
Image Sensor	1/1.9" Exmor CMOS
Effective Pixels	1944(H) x 1092(V), 2 Megapixels
Scanning System	Progressive
Electronic Shutter Speed	1/1 ~ 1/30,000s
Min. Illumination	Color: 0.002Lux@F1.6; B/W: 0.0002Lux@F1.6; 0Lux (IR on)
S/N Ratio	More than 56dB
Video Output	BNC(1.0Vp-p/75Ω), PAL / NTSC
<b>Camera Features</b>	
Day/Night	Auto(ICR) / Color / B/W
Backlight Compensation	BLC / HLC / WDR(120dB)
White Balance	Auto, ATW, Indoor, Outdoor, Manual
Gain Control	Auto / Manual
Noise Reduction	Ultra DNR (2D/3D)
Privacy Masking	Up to 24 areas
Digital Zoom	16x
EIS	Support
Defog	Support
<b>Lens</b>	
Focal Length	6mm~180mm(30x Optical zoom)
Max Aperture	F1.6 ~ F4.8
Focus Control	Auto / Manual
FOV-H	H: 61.2° ~ 2.1°
Close Focus Distance	100mm~ 1000mm
<b>Laser Module</b>	
Laser Control	Auto / Manual
Laser Beam Distance	Up to 500m
Angle of Laser Beam	2° ~ 60°
<b>PTZ</b>	
Pan/Tilt Range	Pan: 0° ~ 360° endless; Tilt: -10° ~ 90°, auto flip 180°
Manual Control Speed	Pan: 0.1° ~ 240° /s; Tilt: 0.1° ~ 120° /s
Preset Speed	Pan: 240° /s; Tilt: 200° /s
Preset	300
PTZ Mode	5 Pattern, 8 Tour, Auto Pan, Auto Scan
Speed Setup	Human-oriented focal length/ speed adaptation
Power up Action	Auto restore to previous PTZ and lens status after power failure
Idle Motion	Activate Preset/ Scan/ Tour/ Pattern if there is no command in the specified period

## DH-SD6AL230F-HNI

Time Task	Auto activation of Preset/ Pan/ Scan/ Tour/ Pattern by preset-time	
Protocol	DH-SD, Pelco-P/D (Auto recognition)	
<b>Video</b>		
Compression	H.264 / MJPEG	
Resolution	1080P(1920×1080) / 720P(1280×720) /D1(704×576/704×480) /CIF(352×288/352×240)	
Frame Rate	Main Stream	1080P/ D1 (1 ~ 25/30fps), 720P(1~50/60fps)
	Sub Stream 1	D1/CIF(1 ~ 25/30fps)
	Sub Stream 2	720P/D1/ CIF (1 ~ 25/30fps)
Bit Rate	H.264: 56K ~ 8192Kbps, MJPEG: 56K ~ 20480Kbps	
<b>Audio</b>		
Compression	G.711a / G.711u(32kbps)/ PCM(128kbps)	
Interface	1/1 channel In/Out	
<b>Intelligent Function</b>		
Auto Tracking	Single-scene, multiple-scene, panorama-scene	
IVS(optional)	Tripwire, Intrusion, Cross Warning Zone, Perimeter Protection, Loitering Detection, Abandoned Object Detection, Missing Object Detection, Illegal Parking, Fast Moving and etc.	
Tracking Trigger Mode	Manual / Auto (alarm triggered)	
Tracking Trigger Event	Targeting, Zoom, Tracking, Recording, Snapshot, Alarm and etc.	
<b>Network</b>		
Ethernet	RJ-45 (10/100Base-T)	
Protocol	IPv4/ IPv6, HTTP, HTTPS, SSL, TCP/IP, UDP, UPnP, ICMP, IGMP, SNMP, RTSP, RTP, SMTP, NTP, DHCP, DNS, PPPOE, DDNS, FTP, IP Filter, QoS, Bonjour, 802.1x	
Compatibility	ONVIF PSIA CGI	
Max. User Access	20 users	
Smart Phone	iPhone, iPad, Android, Windows Phone	
<b>Auxiliary Interface</b>		
Memory Slot	Micro SD, Max 128GB	
Alarm	7/2 channel In/Out	
<b>General</b>		
Power Supply	AC24V/3A(±25%), Hi-POE	
Power Consumption	20W, 43W (IR on)	
Working Environment	-40°C ~ 70°C / Less than 90% RH	
Ingress Protection	IP67	
Wiper	Yes	
Dimensions	Φ240(mm) x 357(mm)	
Weight	6.75kg	

# DH-SD6AL230F-HNI

## Dimensions (mm)

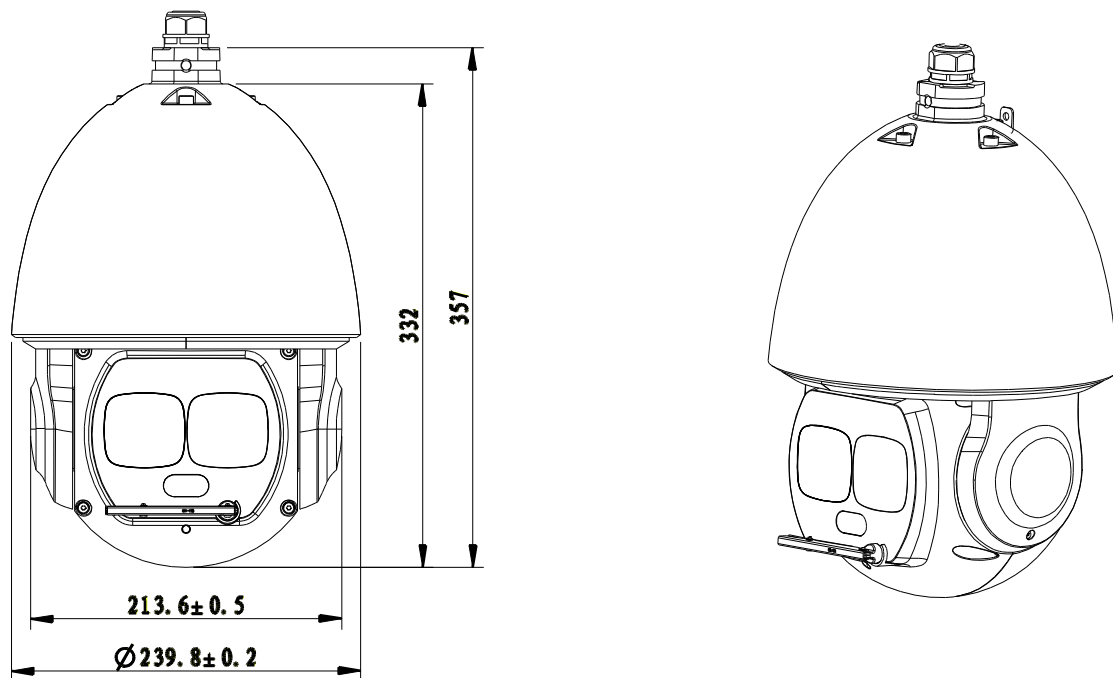

## Accessories

		
DH-PFB303W	DH-PFA111	Power Supply

## Accessories (Optional)

## DH-SD6AL230F-HNI

		
DH-PFB300C	DH-PFA112	DH-PFA113
		
DH- PFA120	DH-PFA150	DH-PFA151

---

### Dahua Technology Co., Ltd.

1199 BinAn Road, Binjiang District, Hangzhou, China

Tel: +86-571-87688883

Fax: +86-571-87688815

Email: [overseas@dahuatech.com](mailto:overseas@dahuatech.com)

[www.dahuasecurity.com](http://www.dahuasecurity.com)

\*Design and specifications are subject to change without notice.

© 2014 Dahua Technology